

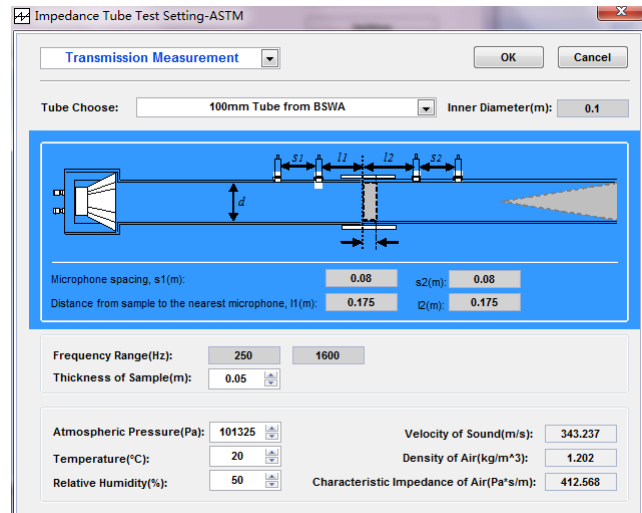

BSWA Impedance Tube Solutions

(Meet both ISO and ASTM Standards)

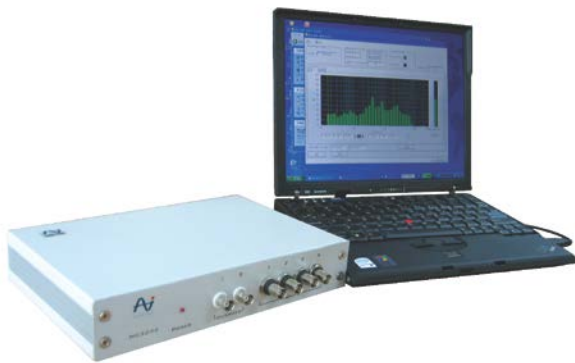

BSWA Company Introduction

Established in 1998, BSWA Technology Co., Ltd. is becoming the preferred supplier for acoustical measurements. With headquarter located in Beijing, BSWA currently employs 100 staffs with branch offices in Shanghai, Guangzhou, and Chengdu. BSWA's products are distributed in over 40 countries through our sales partners.

BSWA Products cover a full range of acoustic measurement devices. The products are sorted into easy-to-follow sections:

- Microphones
- Sound level meter
- Measuring systems
- Material testing
- Audio testing
- Outdoor monitoring systems
- Sound sources
- Cable and accessories

Impedance Tubes

BSWA SW series Impedance Tubes can accurately measure sound absorption coefficients and impedance according to both ISO and ASTM standards. They also support the sound transmission loss measurements based on the Transfer Function Method. The Transfer Function Method separates the incident and reflected energy from the measured transfer function, and then estimates the acoustic properties of the tested sample installed in the tube.

The SW series Impedance Tubes are specially designed not only to work with the cut samples, but also for direct use in the field. The small size and durable aluminum construction make it easy to be transported and used for estimating the properties of walls, ceilings, installed building materials, road surfaces, different ground surfaces, interiors of vehicles, and etc. BSWA offers the complete set of Impedance Tube system, which includes: the tubes, microphones; DAQ hardware and measurement software.

BSWA 1/4" microphones MPA416, which have excellent phase matches, are ideal for impedance applications. The microphones are directly connected to optional 2-channel MC3522 or 4-channel MC3242 data acquisition hardware. PA50 power amplifier is used to drive the loud speaker in the impedance tube. The BSWA VA-Lab software provides all measurement functions for sound absorption and transmission loss testing.

Specifications

BSWA IMPEDANCE TUBES						
Model	SW230	SW260	SW420	SW470	SW422	SW477
Value to be Measured	Sound Absorption Coefficient (α)				Sound Absorption Coefficient (α) and Transmission Loss(TL)	
Standard	GB/T-18696, 2-2002, ISO10534-2, 1998, ASTM E1050-08				Sound Absorption Standard: GB/T-18696, 2-2002, ISO10534-2, 1998; ASTM E1050-08	
					ASTM E2611-09	
Frequency Range (Hz)	125 ~ 3150	125 ~ 6300	63 ~ 1800	800 ~ 6300	63 ~ 1800	800 ~ 6300
Inner Diameter of Testing Tube	60 mm	60 & 30 mm	100 mm	30 mm	100 mm	30 mm
Loud speaker	4 " in diameter, 20 Watts, 8 Ohm					
OPTIONAL ITEMS						
1/4" Microphone	MPA416					
Data Acquisition Card	MC3022+PA50 or MC3522				MC3242	
Power Amplifier	PA50					
Software	VA-Lab2 Basic + VA-Lab2 IMP-A				VA-Lab4 Basic + VA-Lab4 IMP-AT	

Material Testing System

BSWA VA-Lab software has the Impedance Tube Module (VALab IMP) which supports sound absorption and sound insulation measurement for BSWA SW series impedance tubes. The software works with BSWA MC3022, MC3522, MC3242 and MC3642 hardware for data acquisition and analysis. The VA-Lab IMP supports two methods to measure the absorption coefficients of material:

- Method using Standing Wave Ratio (ISO10534-1)
- Transfer Function Method (ISO10534-2, ASTM E1050-08, and ASTM E2611-09)

The VA-Lab IMP also supports four microphones method for sound transmission loss measurements

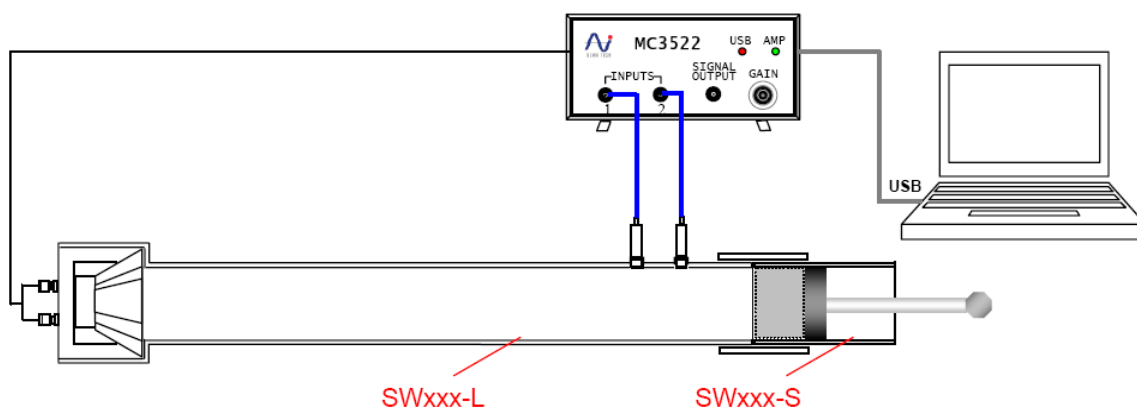

Impedance Tube System for Sound Absorption Measurement

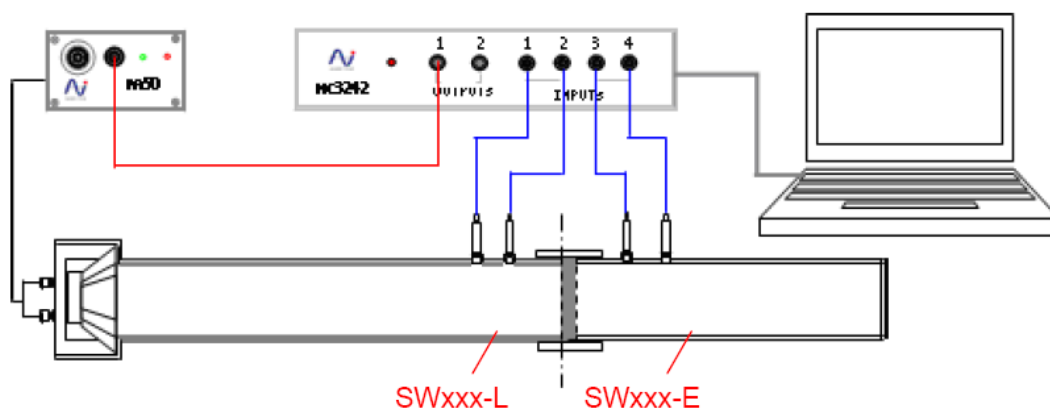

Impedance Tube System for Transmission Loss Measurement

Software Interfaces

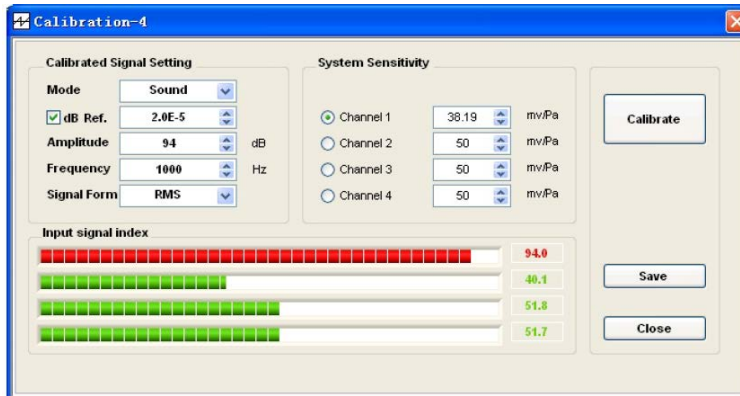

Microphone Calibration Interface

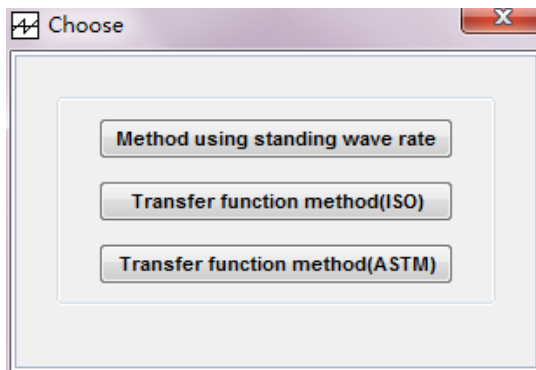

Interface of the Choice of Different Testing Methods

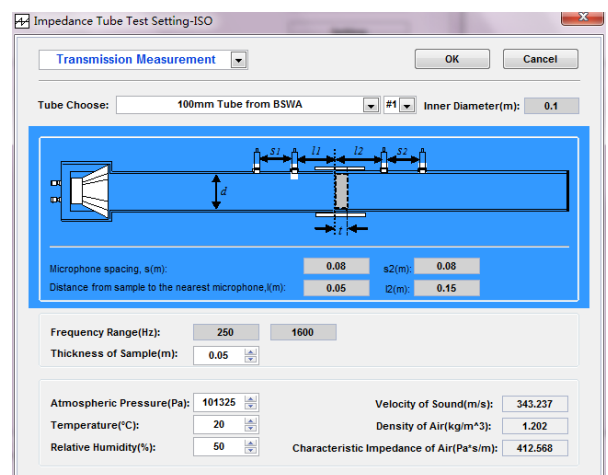
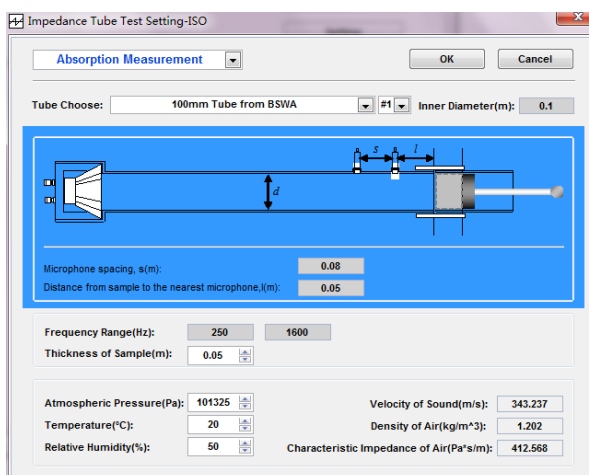

Impedance Tube Setting Interface

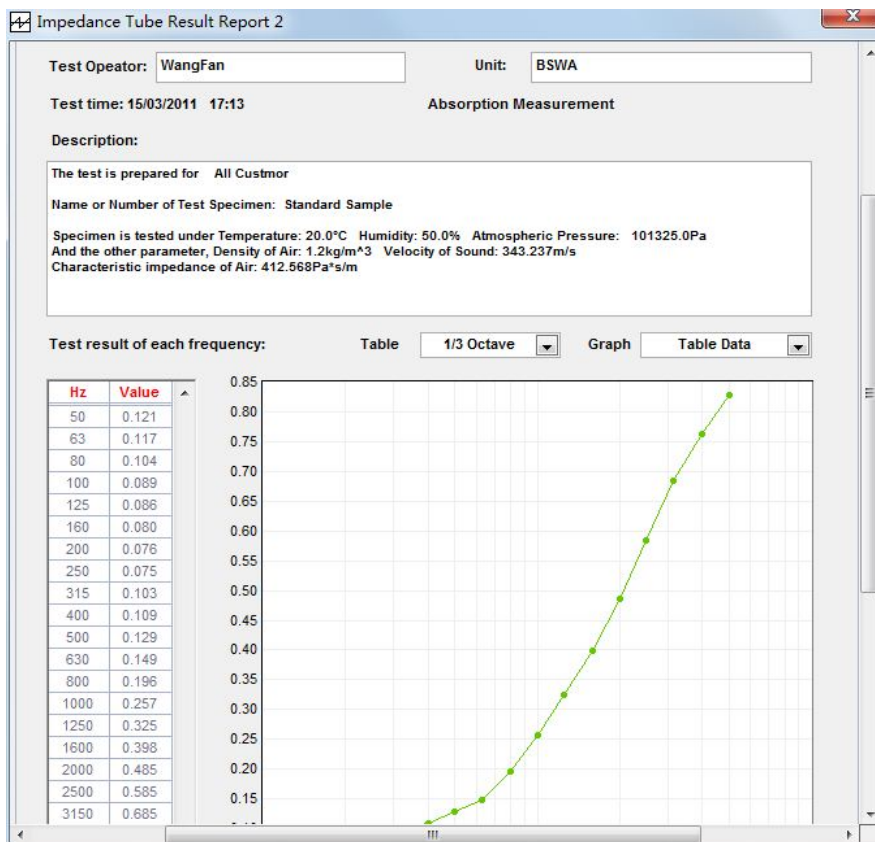
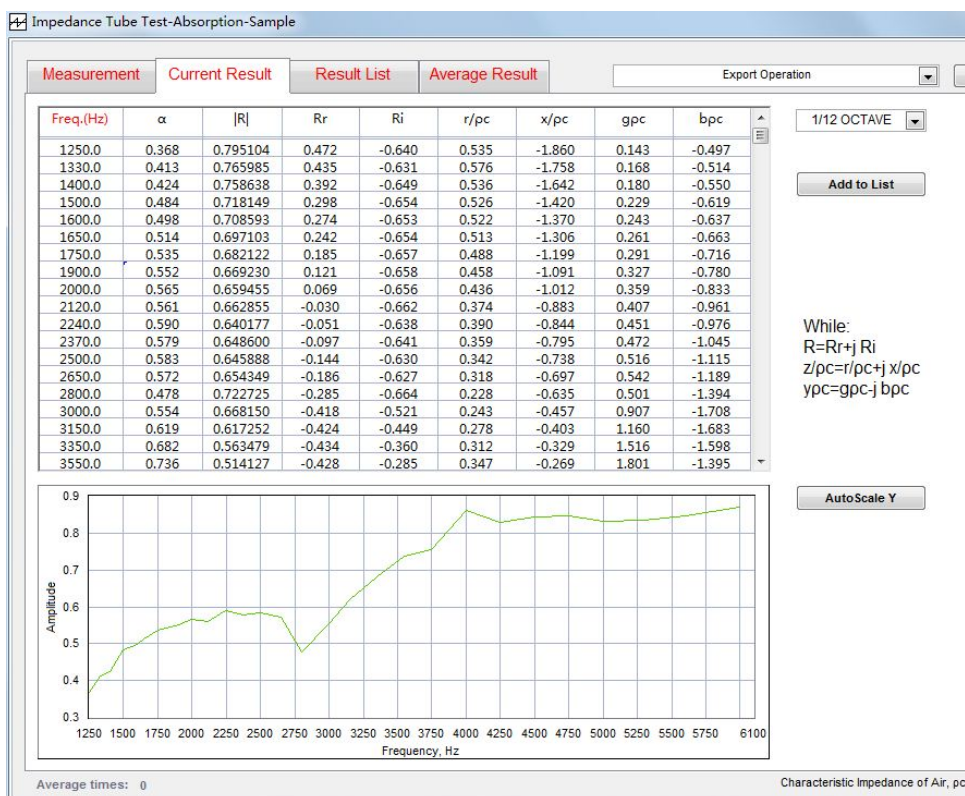

Testing Result and Report

Typical Complete Setup for Measurement of Sound Absorption and Transmission Loss (Frequency Range: 63 Hz ~6300 Hz)

BSWA IMPEDANCE TUBE SYSTEM SW422+SW477			
#	PRODUCT PART #	DESCRIPTION	NUMBER
1	SW422+SW477	Impedance tubes, SW422 is of 100mm inner diameter and SW477 of 30mm inner diameter. For accurate measurement of sound absorption coefficients and transmission loss(63 ~ 6300 Hz) Sound Absorption Standard: GB/T-18696, 2-2002, ISO10534-2, 1998; ASTM E1050-08; Transmission Loss Standard: ASTM E2611-09	1
2	PA50	Power Amplifier of 50W, to power the loudspeaker in the impedance tube	1
3	MC 3242	Analyzer with 4 ICP input channels and 2 signal output channels, USB powered, 0 ~ 20kHz, to be connected with laptop	1
4	MPA 416	1/4" microphone with Integrated ICP Preamplifier	4
5	CBB005	BNC to BNC cables, 5m, to connect PA50 to MC3242	1
6	CBS005	BNC to SMB cables, 5m, to connect MPA416 to MC3242	4
7	CAA002	2m cable of banana connectors, to connect PA50 to the loudspeaker in the impedance tube	1
8	CA115	Sound Calibrator, 1000Hz, 114dB, Type 2, with adaptor for 1/2" and 1/4" microphones	1
9	VA-Lab4 BASIC	Base software module for measurement of noise and vibration, used for 4-channel analyzer	1
10	VA-Lab4 IMP-AT	Software module for measurement of material impedance values (4 mics are needed), for measurement and the calculation of Sound Absorption and Transmission Loss of material.	1

BSWA Technology Co. Ltd

Unit 1003, North Ring Center, #18 Yumin Road, Xicheng District, Beijing 1000029, China

Tel: 86(0)10-51285118

Email: liuwei@bswa.com.cn

Web: www.bswa-tech.com